



SANTALUCIA
MOBILI

Mobilificio Santa Lucia s.p.a.
Via Manin, 34 - 33080
Prata di Pordenone (PN) Italy
T. +39 0434 620525
F. +39 0434 621668
www.santaluciamobili.it
info@santaluciamobili.it

HOMY Night Collection

Anta scorrevole Inserto L.135 / "Inserto" Sliding door W.135



HOMY



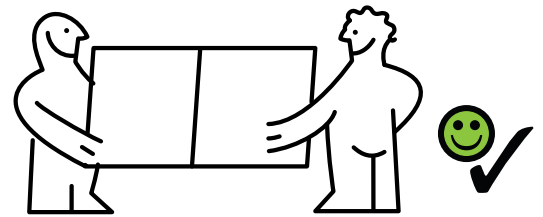
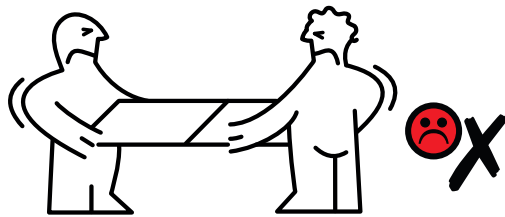
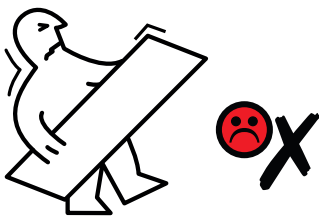
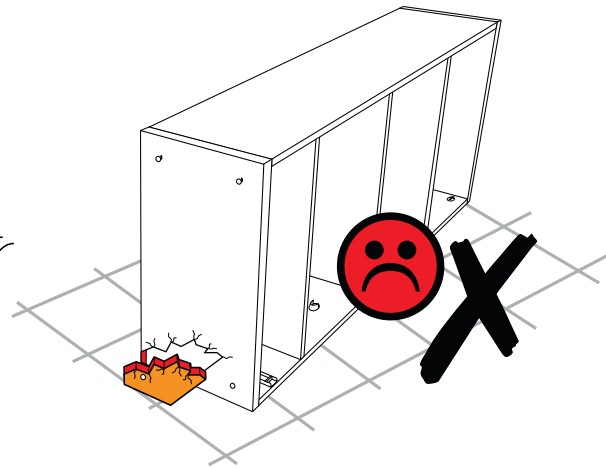
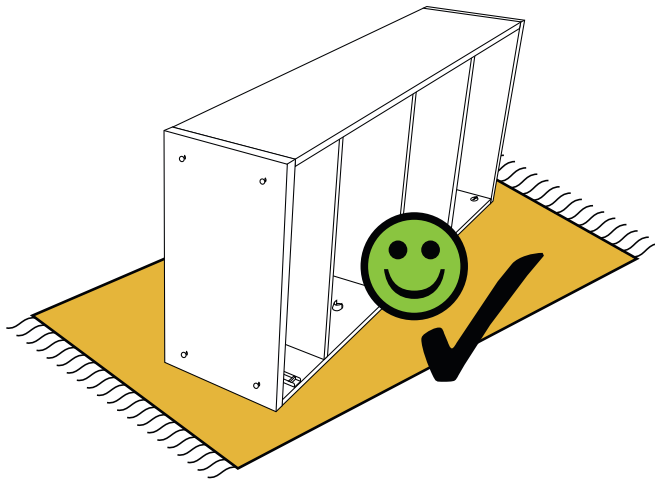
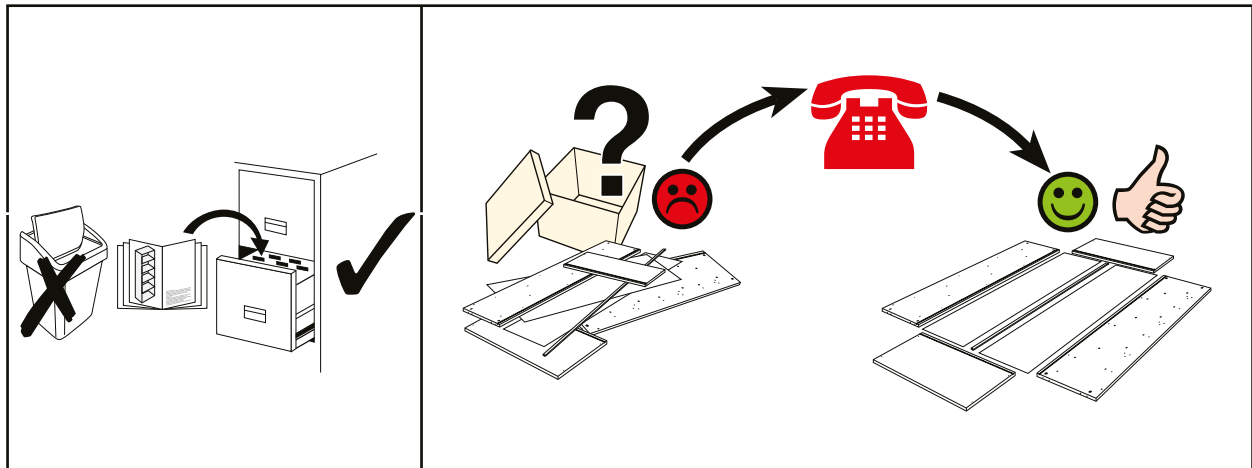

Istruzioni e precauzioni d'uso



I tasselli in dotazione sono idonei per muri in cemento armato o mattoni pieni.
È responsabilità dell'installatore l'utilizzo di tasselli idonei al tipo di muro e installazione.
Per eseguire il montaggio, attenersi alle istruzioni e agli schemi tecnici inseriti nelle confezioni di ferramenta.
Usare scrupolosamente la ferramenta in dotazione.

Instructions for use and precautions



The dowels supplied are suitable for reinforced concrete walls or solid bricks. It is the installer's responsibility to use dowels suitable for the type of the wall and installation.
Follow the technical drawings included in the hardware packaging for installation.
Carefully use the supplied hardware.



SANTALUCIA
MOBILI

Mobilificio Santa Lucia s.p.a.
Via Manin, 34 - 33080
Prata di Pordenone (PN) Italy
T. +39 0434 620525
F. +39 0434 621668
www.santaluciamobili.it
info@santaluciamobili.it

HOMY Night Collection

Anta scorrevole Inserto L.135 / "Inserto" Sliding door W.135



HOMY

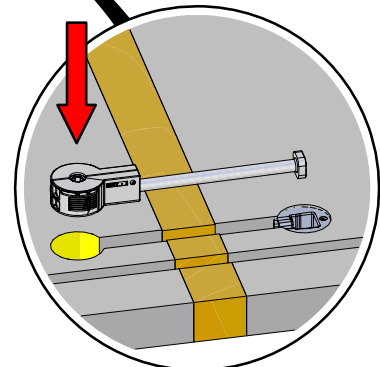
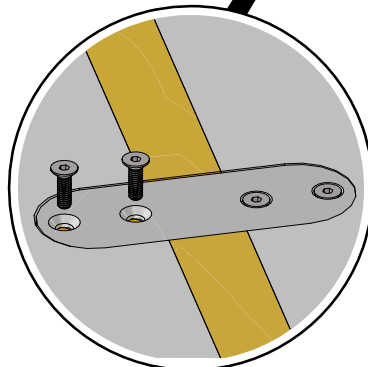
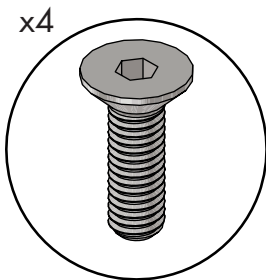
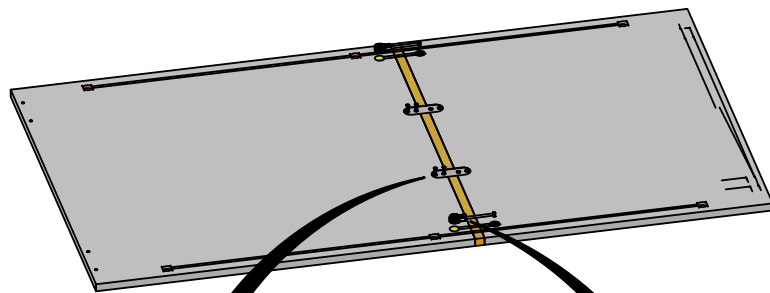
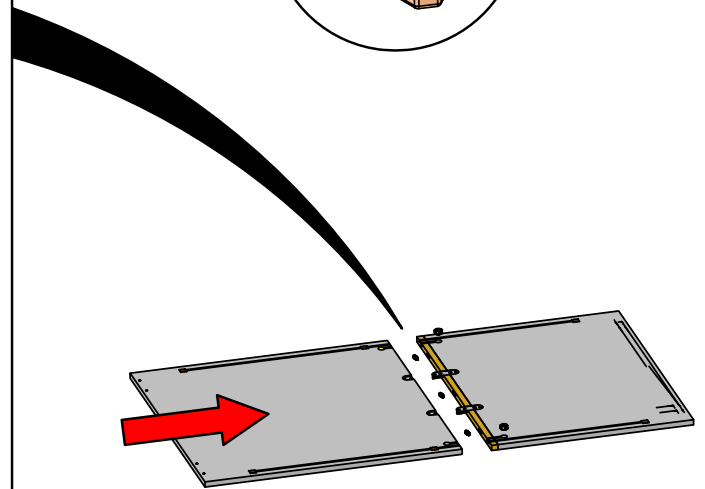
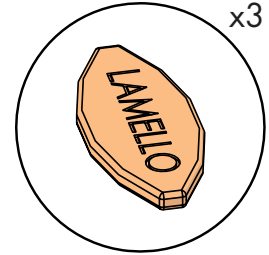
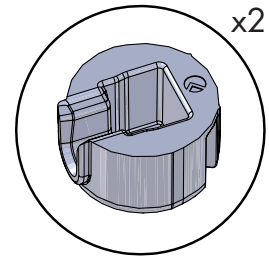
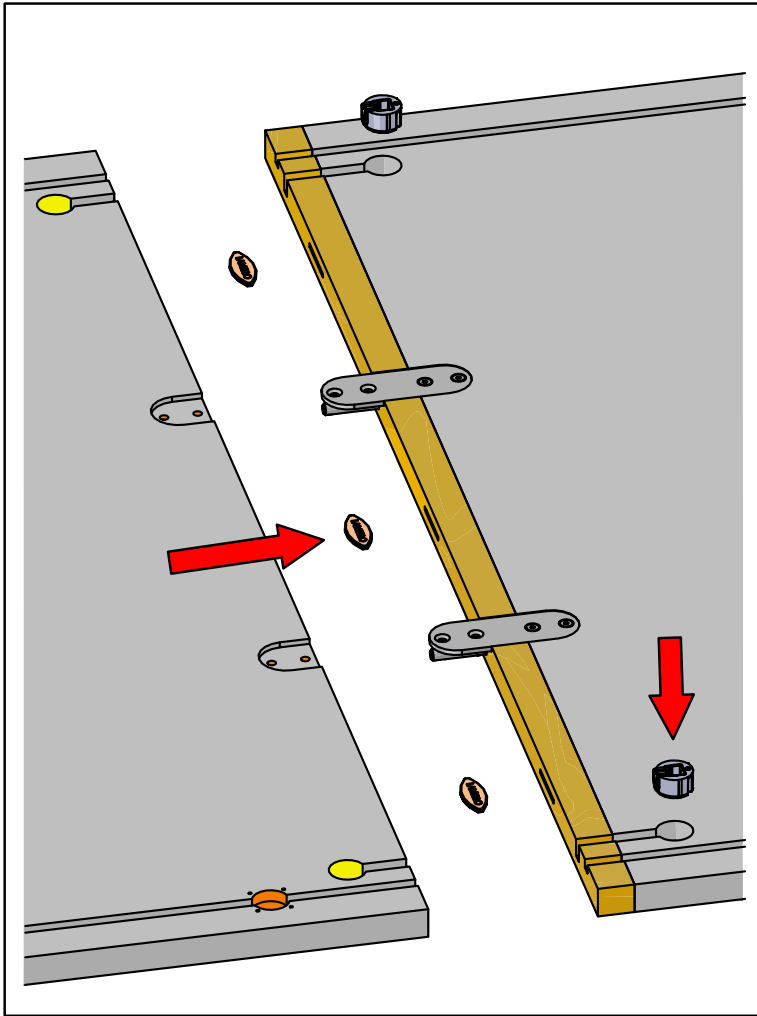

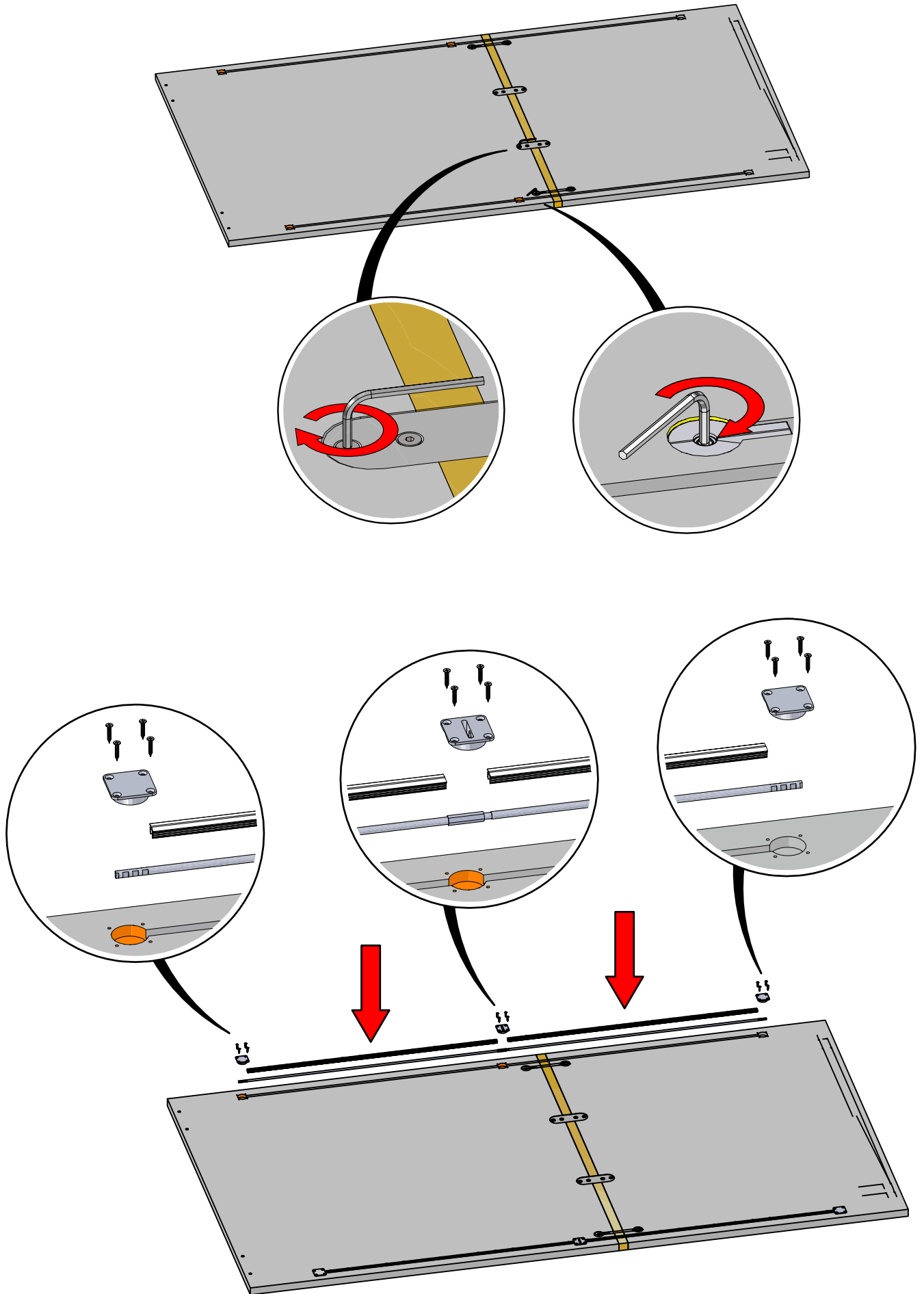

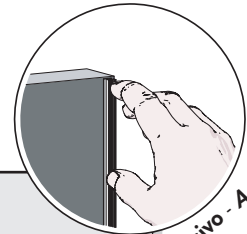
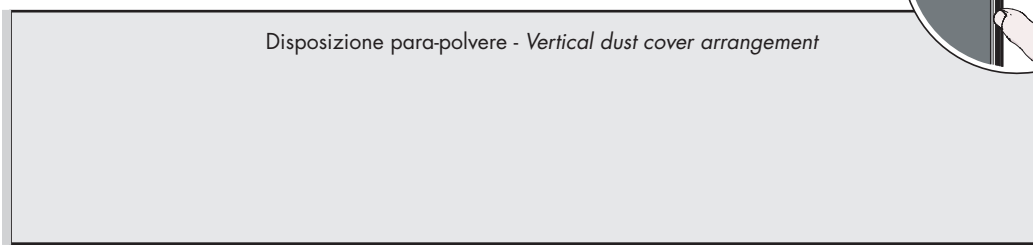
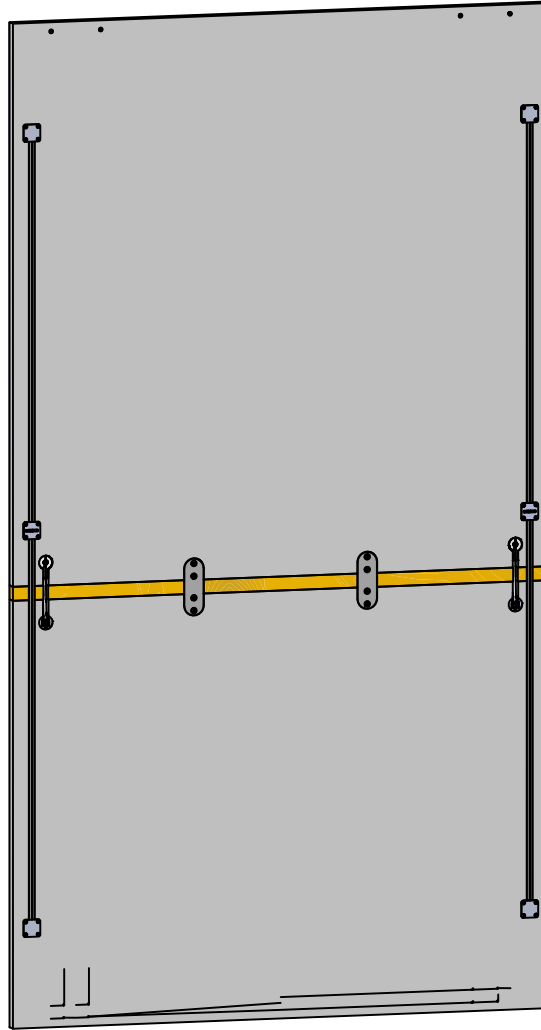

Adesivo - Adhesive

Anta interna - Internal door

Anta esterna - External door

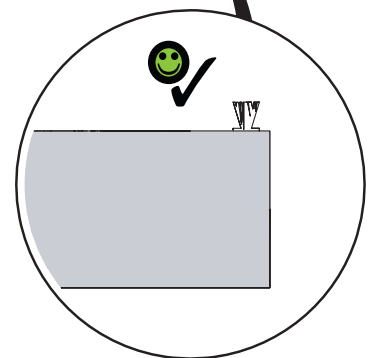
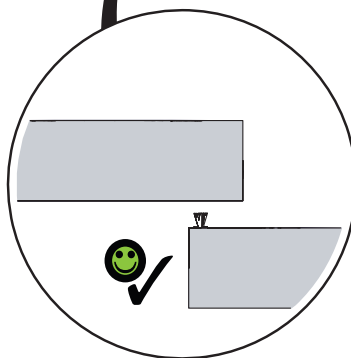
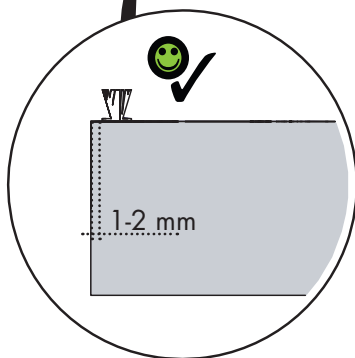

Regolare i tenditori per correggere eventuali deformazioni dell'anta una volta installata sull'armadio

Adjust the tensioners to correct any deformation of the door once installed on the cabinet

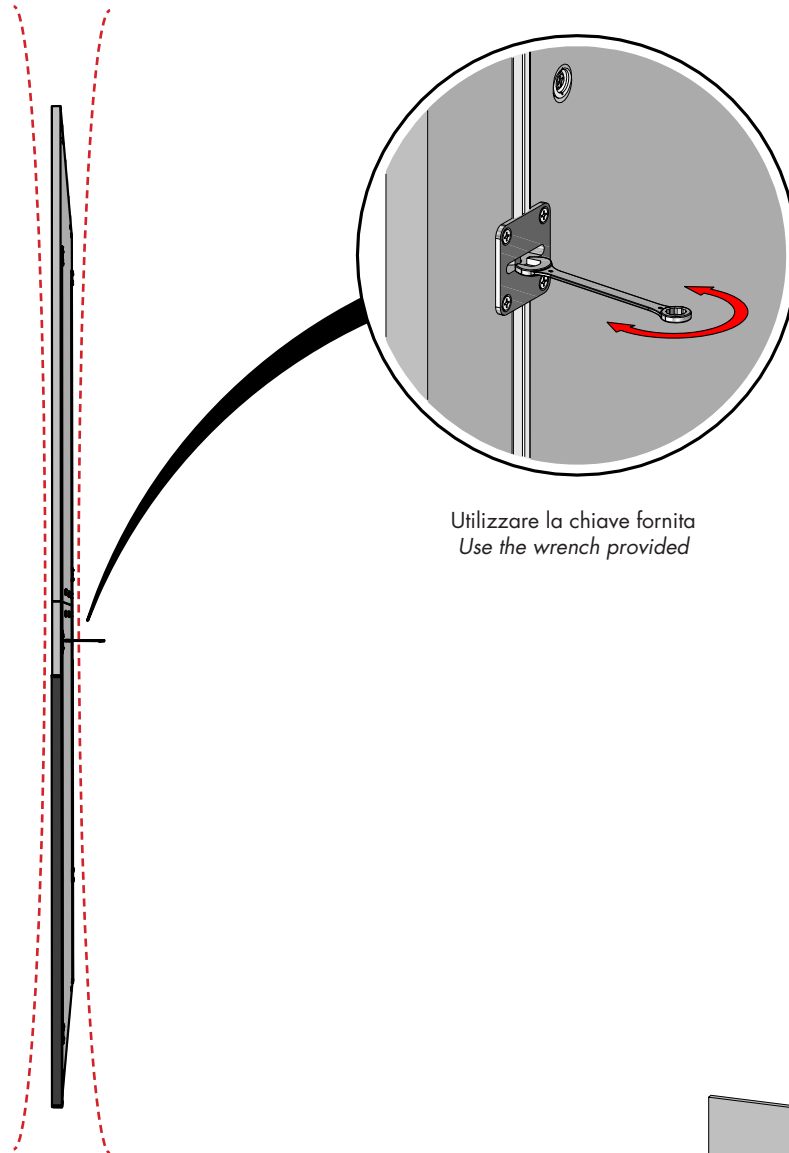

Utilizzare la chiave fornita
Use the wrench provided

