

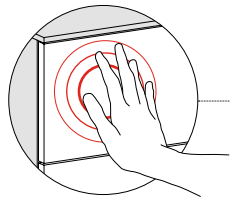

SEZIONE Frontale

Front SECTION



apertura tramite push & pull (di serie)
opening by push & pull (standard)

piedino regolabile h.23 di serie
standard h.23 levelling feet

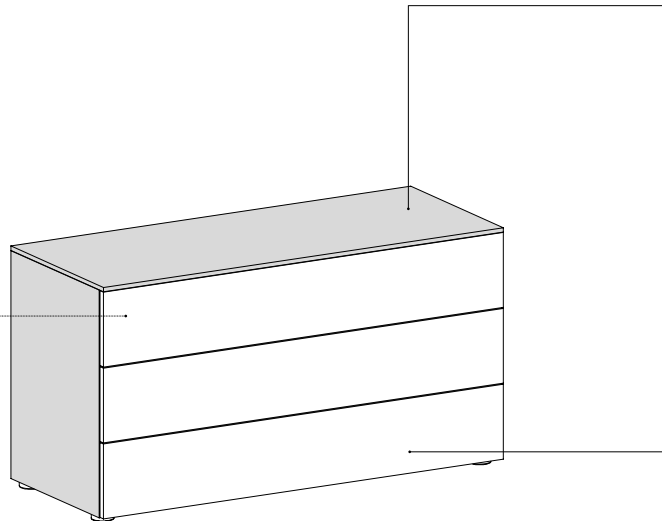

Finiture SCOCCA
BODY Finishes

ES / essenza
EH / essenza light
CE / colore eco
LO / laccato opaco
LL / laccato lucido

Finiture FRONTALI
FRONTS Finishes

ES / essenza
EH / essenza light
IM / impiallacciato
CE / colore eco
LO / laccato opaco
LL / laccato lucido
SC / essenza scult
SL / laccato opaco scult
MT / concrete
TR / trama

- _ I moduli sono dotati di top Sp.12 della stessa finitura della scocca.
- _ I cassetti, se provvisti di maniglia, sono dotati di rallentatori.
- _ In alternativa ai piedini regolatori di serie, i moduli possono essere dotati di zoccolatura H.23 o staffe.
- _ Se appesi o se sovrapposti ad altri, i moduli devono essere obbligatoriamente dotati di attaccaglie per fissaggio a muro.
- _ **NON SI ESEGUONO LAVORAZIONI SU MISURA.**

- _ The modules are equipped with Thk.12 top in the same finish as the body.
- _ If equipped with handles the drawers are equipped with soft closing runners.
- _ As alternative to standard levelling feet, the modules can be equipped by H.23 plinth or brackets.
- _ If the modules are hung or superimposed on others must be mandatorily equipped with the bracket kit for wall-mounting kit.
- _ **CUSTOMIZATION NOT POSSIBLE.**

Larghezza
Width

460

613

766

919

1225

1378

1531

Altezza
Height

243 (220+23)

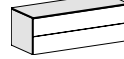
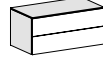
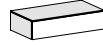
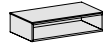

451 (428+23)

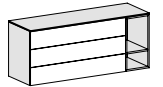
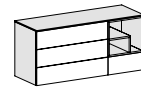
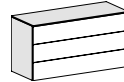
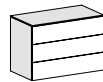

659 (636+23)

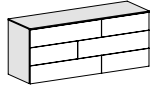
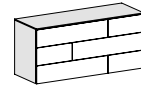
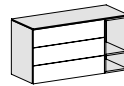

867 (844+23)

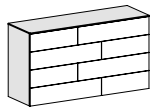
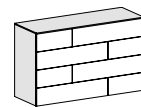

1283 (1260+23)

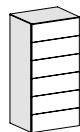

Maniglia MNG 240
Handle MNG 240

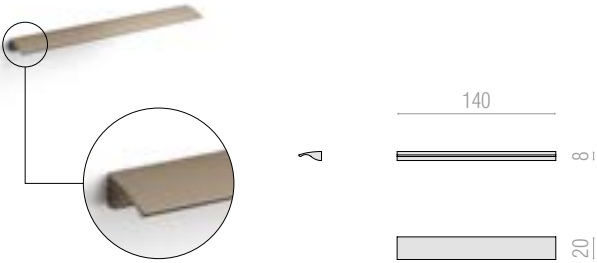

Maniglia MNG 532
Handle MNG 532

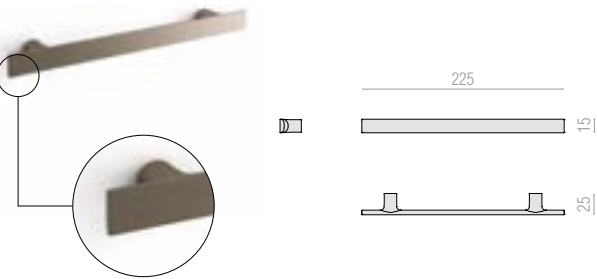

Maniglia MNG 285
Handle MNG 285

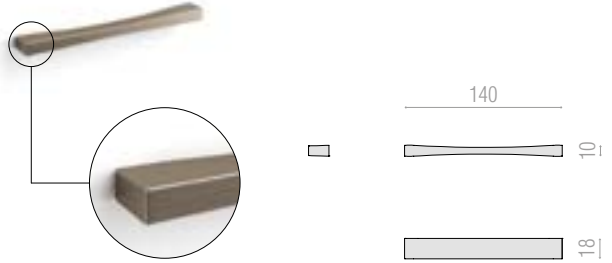

Maniglia MNG 533
Handle MNG 533

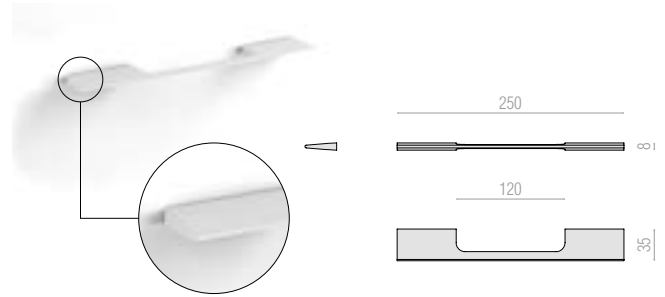

Basamenti disponibili

Plinthes available

Piedino H.23 (di serie)

H.23 Feet (standard)



Basamento Plexi

Plexi Plinth



Basamento Corner

Corner Plinth



Largh. (mm): 460, 613, 766, 919, 1225, 1378, 1531
Widht (mm):

Largh. (mm): 460, 613, 766, 919, 1225, 1378, 1531
Widht (mm):

Accessori

Accessories

Faretto Illumina Cassetto

Drawer Spotlight

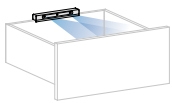

Lampada Snodabile con 2 porte USB

Adjustable Lamp with 2 USB ports

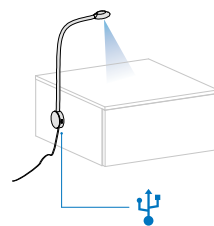

Guide ad estrazione totale per cassetto

Full-extension Runners

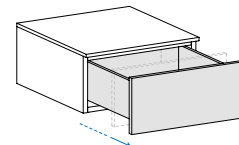

Portariviste Vetro L.153 (Vetro Stopsol)

Glass Magazine Rack W.153 (Stopsol Glass)

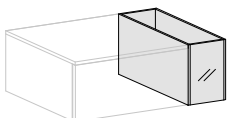

Il Portariviste può essere posizionato a Sinistra o a Destra del modulo.

The Glass Magazine Rack can be positioned on the left or right of the module.

Via Manin, 34 - 33080 - Prata di Pordenone (PN) Italy
T. +39 0434 620525
F. +39 0434 62 1668
C. F. - P. iva - Reg. Imprese: 00071810931

www.santaluciamobili.it
info@santaluciamobili.it

**I contenuti e le immagini sono di proprietà del Mobilificio Santa Lucia SpA.
Tutti i diritti riservati.**

Materiale informativo e promozionale gratuito non destinato alla vendita.
Escluso iva art.2 comma 3 D.P.R. 633/72 - esonerato da documento di trasporto art.4 punto 6 D.P.R. 627/78.

Il Mobilificio Santa Lucia S.p.A. si riserva di apportare tutte le modifiche volte al miglioramento tecnico e qualitativo dei propri prodotti.

Finiture, materiali e colori raffigurati in questo divulgativo sono puramente indicativi e possono subire variazioni cromatiche dovute alla tecnica di stampa.

L'azienda declina qualsiasi responsabilità che derivi da possibili refusi di stampa e/o da eventuali inesattezze sulle caratteristiche dei propri prodotti.

*The contents and images are the property of Santa Lucia SpA.
All rights reserved.*

*Free information and promotional material not intended for sale.
Excluding VAT art.2 paragraph 3 D.P.R. 633/72 - exempted from document of transport art.4 point 6 D.P.R. 627/78.*

The Santa Lucia S.p.A. reserves the right to make any changes aimed at technical and quality improvement of its products, without notice.

The finishes, materials and colors shown in this price list are purely indicative and may undergo chromatic variations due to the printing technique.

The company declines any responsibility from possible printing typos or any inaccuracies in the characteristics of its products.

SEGUICI /FOLLOW US



[/SantaluciaMobili](#)



[/santalucia_mobili](#)



[/santalucia-mobili](#)



[/santaluciamobili](#)



[/c/SANTALUCIAMOBILI_1965](#)