

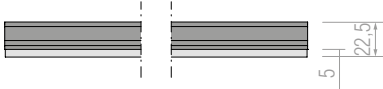

**SEZIONE Frontale**  
*Front SECTION*



**Cassetto Superiore**  
*Upper Drawer*



**Cassetto Inferiore**  
*Lower Drawer*

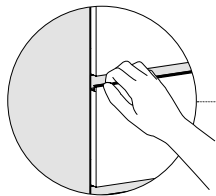

apertura tramite presa gola  
*opening by groove profile grip*

pedino regolabile h.23 di serie  
*standard h.23 levelling feet*

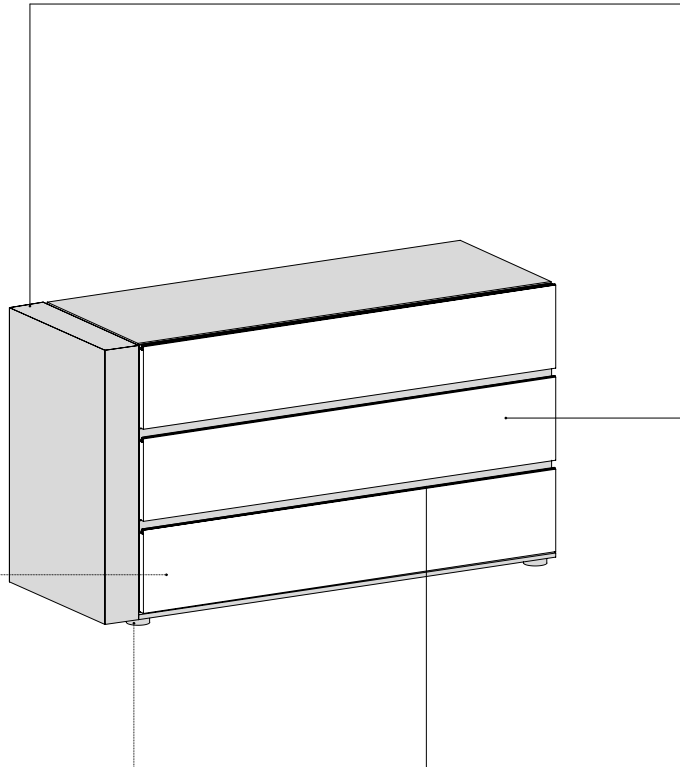

**Finiture FIANCONE e  
BASAMENTO**  
*BIG SIDE PANEL &  
PLINTH Finishes*

**ES** / essenza  
**CE** / colore eco  
**SN** / materico  
**SM** / marmoreo  
**LO** / laccato opaco  
**LL** / laccato lucido  
**LZ** / laccato metallizzato

**Finiture SCOCCA e  
FRONTALI**  
*BODY & FRONTS Finishes*

**ES** / essenza  
**CE** / colore eco  
**SN** / materico  
**LO** / laccato opaco  
**LL** / laccato lucido  
**LZ** / laccato metallizzato

**Finiture PROFILO GOLA**  
*GROOVE PROFILE Finishes*

**LO** / laccato opaco  
**LZ** / laccato metallizzato

I comodini e settimanali possono essere sinistri o destri in base alla posizione del fiancone.

*Bedside tables & chest of drawers can be left or right depending on the big side panel position.*

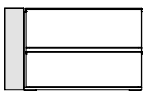

**Sx**  
*Lh*

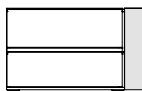

**Dx**  
*Rh*

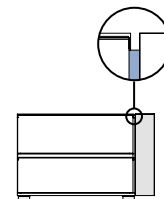

**Finiture DIVISIONE Sp.30**  
*Thk.30 DIVIDER Finishes*

**LZ** / laccato metallizzato

- \_ I cassetti sono dotati di guide scorrevoli rallentate.
- \_ Il settimanale e il comò sono dotati di kit antiribaltamento.
- \_ I cassetti del comò sono dotati di stabilizzatore antisbandieramento.
- \_ I moduli non possono essere appesi a parete.
- \_ **NON SI ESEGUONO LAVORAZIONI SU MISURA.**

- \_ *The drawers are equipped with slowed sliding runners.*
- \_ *The chest and dresser have anti-tip kit.*
- \_ *The dresser drawers are fitted with an anti-slipping stabiliser.*
- \_ *The units cannot be hung on the wall.*
- \_ **CUSTOMIZATION NOT POSSIBLE.**

**Comodino 2 cassetti L.513**

W.513 2-drawer Bedside Table

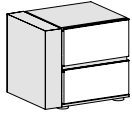

L: 513 H: 454 P: 406  
W: W: H: H: D: D:

**Comodino 2 cassetti L.724**

W.724 2-drawer Bedside Table

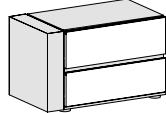

L: 724 H: 454 P: 406  
W: W: H: H: D: D:

**Comò 3 cassetti**

3-drawer Dresser

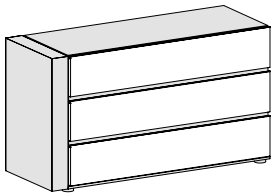

L: 1336 H: 752 P: 493  
W: W: H: H: D: D:

**Settimanale 6 cassetti**

Chest of 6 drawers

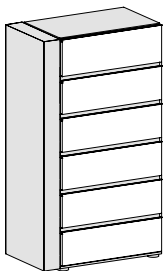

L: 724 H: 1286 P: 406  
W: W: H: H: D: D:

**Lampada Dolomite**

*Dolomite Lamp*

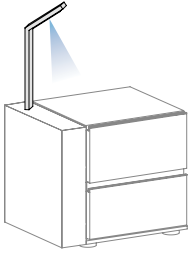

**Led Temporizzato per Cassetto**

*LED with timer for drawer*

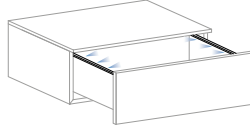

**Disponibile su comodino 2 cassetti**

*Available on 2-drawer bedside table*

**Presa Elettrica (ad incasso)**

*Electrical Socket (recessed)*

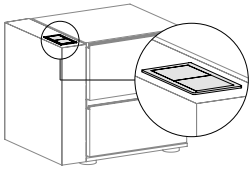

**Tipologia**  
*Typology*

1 Schuko

2 USB\*

\* 1 Usb A + 1 Usb C

**Presa Usb Quadrata (ad incasso)**

*Square Usb Socket (recessed)*

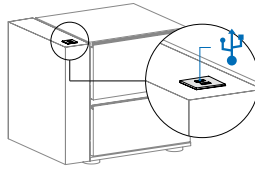

**Carica Batterie Induzione (ad incasso)**

*Induction Charger (recessed)*

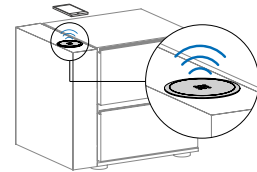

Via Manin, 34 - 33080 - Prata di Pordenone (PN) Italy  
T. +39 0434 620525  
F. +39 0434 62 1668  
C. F. - P. iva - Reg. Imprese: 00071810931

[www.santaluciamobili.it](http://www.santaluciamobili.it)  
[info@santaluciamobili.it](mailto:info@santaluciamobili.it)

**I contenuti e le immagini sono di proprietà del Mobilificio Santa Lucia SpA.  
Tutti i diritti riservati.**

Materiale informativo e promozionale gratuito non destinato alla vendita.  
Escluso iva art.2 comma 3 D.P.R. 633/72 - esonerato da documento di trasporto art.4 punto 6 D.P.R. 627/78.

Il Mobilificio Santa Lucia S.p.A. si riserva di apportare tutte le modifiche volte al miglioramento tecnico e qualitativo dei propri prodotti.

Finiture, materiali e colori raffigurati in questo divulgativo sono puramente indicativi e possono subire variazioni cromatiche dovute alla tecnica di stampa.

L'azienda declina qualsiasi responsabilità che derivi da possibili refusi di stampa e/o da eventuali inesattezze sulle caratteristiche dei propri prodotti.

*The contents and images are the property of Santa Lucia SpA.  
All rights reserved.*

*Free information and promotional material not intended for sale.  
Excluding VAT art.2 paragraph 3 D.P.R. 633/72 - exempted from document of transport art.4 point 6 D.P.R. 627/78.*

*The Santa Lucia S.p.A. reserves the right to make any changes aimed at technical and quality improvement of its products, without notice.*

*The finishes, materials and colors shown in this price list are purely indicative and may undergo chromatic variations due to the printing technique.*

*The company declines any responsibility from possible printing typos or any inaccuracies in the characteristics of its products.*

## SEGUICI / FOLLOW US



[/SantaluciaMobili](#)



[/santalucia\\_mobili](#)



[/santalucia-mobili](#)



[/santaluciamobili](#)



[/c/SANTALUCIAMOBILI\\_1965](#)