

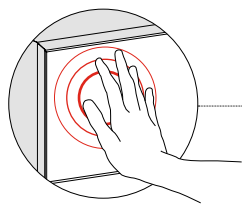

HOMY

SEZIONE Frontale

Front SECTION

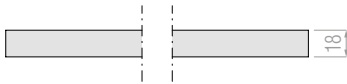

apertura tramite push & pull
opening by push & pull

piedino regolabile h.15 di serie
standard h.15 levelling feet

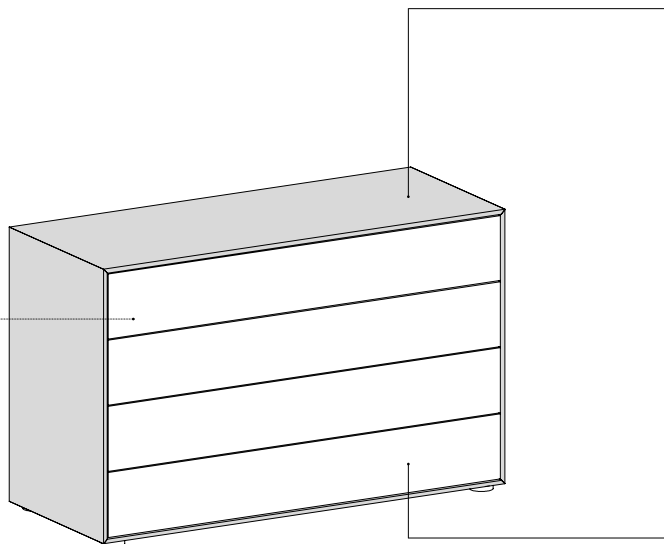

Finiture SCOCCA

BODY Finishes

ES / essenza
CE / colore eco
LO / laccato opaco
LL / laccato lucido

Finiture FRONTALI

FRONTS Finishes

ES / essenza
CE / colore eco
LO / laccato opaco
LL / laccato lucido
MT / concrete

- _ Le scocche dei moduli sono in folding, pannelli giuntati a 45°.
- _ Il settimanale e il comò sono dotati di kit anti-ribaltamento.
- _ **NON SI ESEGUONO LAVORAZIONI SU MISURA.**

- _ The body of the modules are in folding wooden, joined at 45° panels.
- _ The chest and dresser have anti-tip kit.
- _ **CUSTOMIZATION NOT POSSIBLE.**

Comodino 2 cassetti

2-drawer Bedside Table

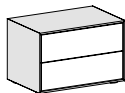

L: 613 H: 404 P: 400
W: W: H: H: D: D:

Comodino 3 cassetti

3-drawer Bedside Table

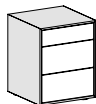

L: 400 H: 511 P: 400
W: W: H: H: D: D:

Comodino 3 cassetti

3-drawer Bedside Table

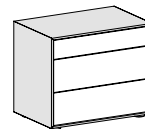

L: 613 H: 511 P: 400
W: W: H: H: D: D:

Comò 4 cassetti

4-drawer Dresser

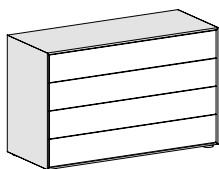

L: 1226 H: 766 P: 500
W: W: H: H: D: D:

Settimanale 7 cassetti

Chest of 7 drawers

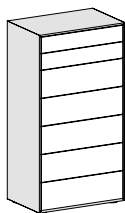

L: 613 H: 1161 P: 400
W: W: H: H: D: D:

Faretto Illumina Cassetto

Drawer Spotlight

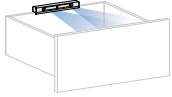

Lampada Snodabile con 2 porte USB

Adjustable Lamp with 2 USB ports

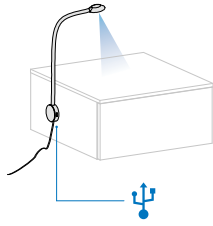

Guide ad estrazione totale per cassetto

Full-extension Runners

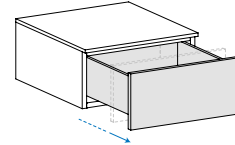

Via Manin, 34 - 33080 - Prata di Pordenone (PN) Italy
T. +39 0434 620525
F. +39 0434 62 1668
C. F. - P. iva - Reg. Imprese: 00071810931

www.santaluciamobili.it
info@santaluciamobili.it

**I contenuti e le immagini sono di proprietà del Mobilificio Santa Lucia SpA.
Tutti i diritti riservati.**

Materiale informativo e promozionale gratuito non destinato alla vendita.
Escluso iva art.2 comma 3 D.P.R. 633/72 - esonerato da documento di trasporto art.4 punto 6 D.P.R. 627/78.

Il Mobilificio Santa Lucia S.p.A. si riserva di apportare tutte le modifiche volte al miglioramento tecnico e qualitativo dei propri prodotti.

Finiture, materiali e colori raffigurati in questo divulgativo sono puramente indicativi e possono subire variazioni cromatiche dovute alla tecnica di stampa.

L'azienda declina qualsiasi responsabilità che derivi da possibili refusi di stampa e/o da eventuali inesattezze sulle caratteristiche dei propri prodotti.

*The contents and images are the property of Santa Lucia SpA.
All rights reserved.*

*Free information and promotional material not intended for sale.
Excluding VAT art.2 paragraph 3 D.P.R. 633/72 - exempted from document of transport art.4 point 6 D.P.R. 627/78.*

The Santa Lucia S.p.A. reserves the right to make any changes aimed at technical and quality improvement of its products, without notice.

The finishes, materials and colors shown in this price list are purely indicative and may undergo chromatic variations due to the printing technique.

The company declines any responsibility from possible printing typos or any inaccuracies in the characteristics of its products.

SEGUICI /FOLLOW US



[/SantaluciaMobili](#)



[/santalucia_mobili](#)



[/santalucia-mobili](#)



[/santaluciamobili](#)



[/c/SANTALUCIAMOBILI_1965](#)